

ABSS138ES-HF

**N-Channel
RoHS Device
Halogen Free**

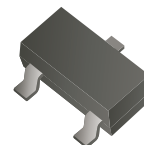

Features

- Low on-resistance.
- Low input capacitance.
- Fast switching speed.
- ESD protection up to 1.5kV (human body mode).
- AEC-Q101 Qualified.

Mechanical data

- Case: SOT-23, molded plastic.
- Molding compound: UL flammability classification rating 94V-0.
- Terminals: Tin-plated; solderability per MIL-STD-202, method 208.

Circuit Diagram

- G : Gate
- S : Source
- D : Drain

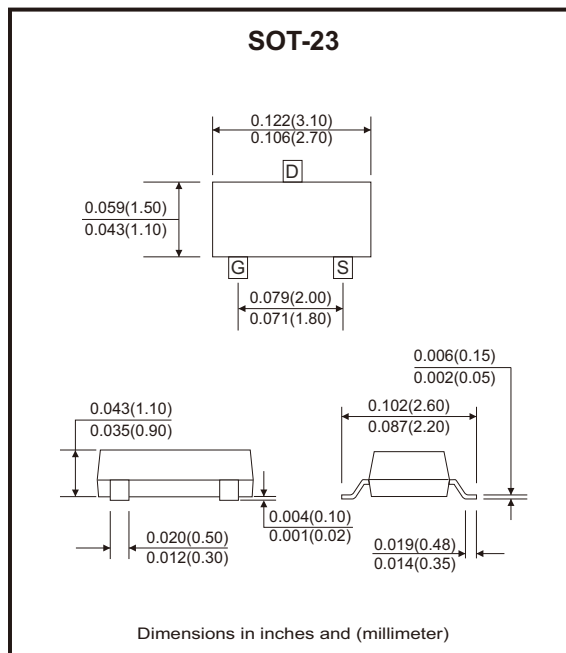
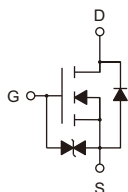

Maximum Ratings (at TA=25°C unless otherwise noted)

Parameter	Symbol	Value	Unit
Drain-source voltage	V _{DS}	50	V
Gate-source voltage	V _{GS}	±20	V
Continuous drain current (Note 1)	I _D	360	mA
Pulsed drain current	I _{DM}	1200	mA
Single pulse avalanche energy (Note 4)	E _{AS}	0.2	mJ
Power dissipation (Note 1)	P _D	0.35	W
Thermal resistance junction to air (Note 1)	R _{θJA}	370	°C/W
Thermal resistance junction to lead (Note 1)	R _{θJL}	222	
Thermal resistance junction to case (Note 1)	R _{θJC}	187	
Operating junction temperature range	T _J	-55 to +150	°C
Storage temperature range	T _{STG}	-55 to +150	°C

Electrical Characteristics (at $T_A=25^{\circ}\text{C}$ unless otherwise noted)

Parameter	Symbol	Conditions	Min	Typ	Max	Unit
Static Characteristics						
Drain-source breakdown voltage	BV_{DSS}	$V_{GS} = 0V, I_D = 250\mu A$	50			V
Zero gate voltage drain current	I_{DSS}	$V_{DS} = 50V, V_{GS} = 0V$			1	μA
Gate-body leakage current	I_{GSS}	$V_{GS} = \pm 20V, V_{DS} = 0V$			± 10	μA
On Characteristics (Note 2)						
Static drain-source on-resistance	$R_{DS(on)}$	$V_{GS} = 10V, I_D = 0.5A$		1	1.6	Ω
	$R_{DS(on)}$	$V_{GS} = 4.5V, I_D = 0.2A$		1.2	2.5	Ω
	$R_{DS(on)}$	$V_{GS} = 2.5V, I_D = 0.1A$		1.7	4.5	Ω
Gate threshold voltage	$V_{GS(th)}$	$V_{DS} = V_{GS}, I_D = 250\mu A$	0.8	1	1.5	V
Dynamic Characteristics						
Input capacitance	C_{iss}	$V_{GS} = 0V, V_{DS} = 25V, f = 1MHz$		51		μF
Output capacitance	C_{oss}			17		
Reverse transfer capacitance	C_{rss}			9		
Total gate charge	Q_g	$V_{DS} = 25V, V_{GS} = 10V, I_D = 0.2A$		4		nC
Gate to source charge	Q_{gs}			0.5		
Gate to drain (miller) charge	Q_{gd}			0.4		
Switching Characteristics (Note 3)						
Turn-on delay time	$t_{d(on)}$	$V_{DD} = 25V, I_D = 0.36A$ $V_{GS} = 10V, R_G = 6\Omega$		2.2		ns
Turn-on rise time	t_r			19.2		
Turn-off delay time	$t_{d(off)}$			6.2		
Turn-off fall time	t_f			23		
Source-Drain Diode Characteristics						
Diode forward voltage (Note 1)	V_{SD}	$I_S = 0.5A, V_{GS} = 0V$		0.89	1.4	V
Maximum continuous drain source diode forward current	I_S				0.36	A
Reverse recovery time	t_{rr}	$I_F = 1A, dI_F/dt = 100A/\mu s$		20		ns
Reverse recovery charge	Q_{rr}				10.7	

Notes: 1. Surface mounted on FR4 board, and standard footprint, $t \leq 10$ sec.

2. Pulse test: pulse width $\leq 300\mu s$, duty cycle $\leq 2\%$.

3. Guaranteed by design, not subject to production.

4. The EAS data shows Max. rating. The test condition is $V_{DS}=48V, V_{GS}=10V, L=0.5mH, R_G=25\Omega$.

Rating and Characteristic Curves (ABSS138ES-HF)

Fig.1 - Output Characteristics

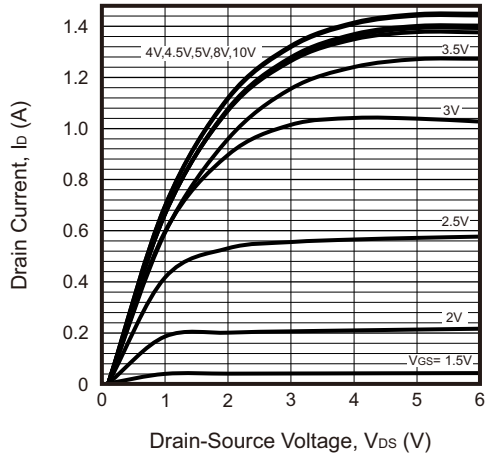

Fig.2 - On-Resistance vs. Drain Current and Gate Voltage

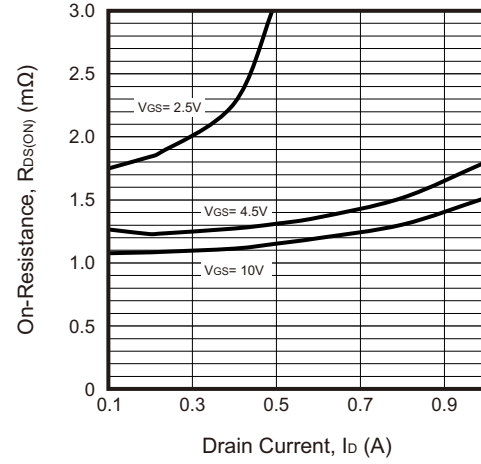

Fig.3 - On-Resistance vs. Gate-Source Voltage

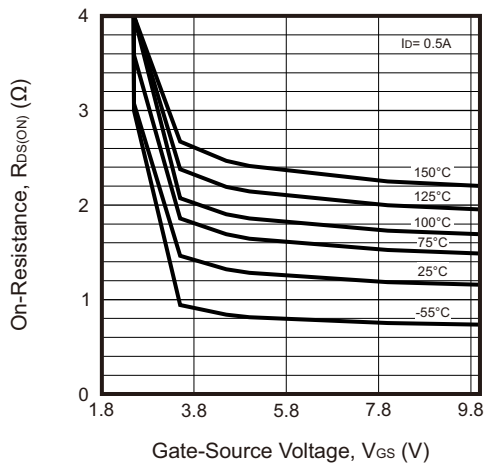

Fig.4 - Body-Diode Characteristics

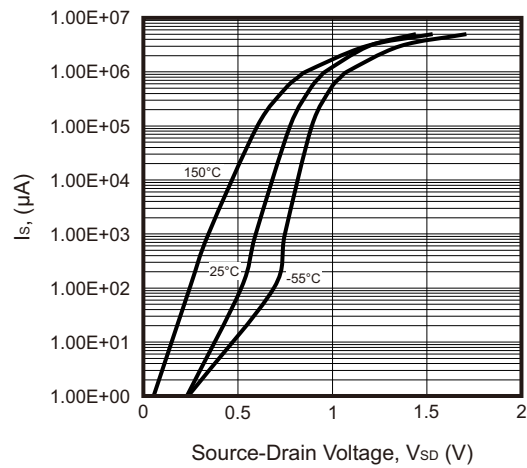

Fig.5 - On-Resistance vs. Junction Temperature

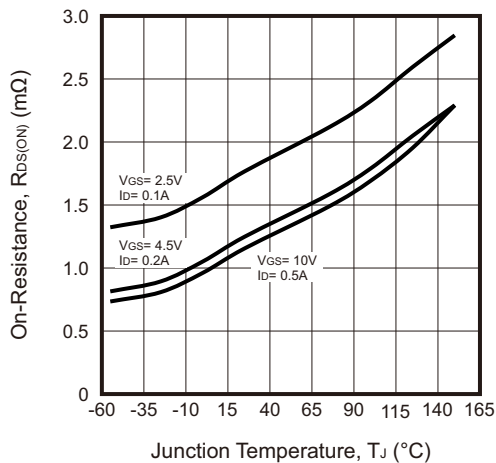
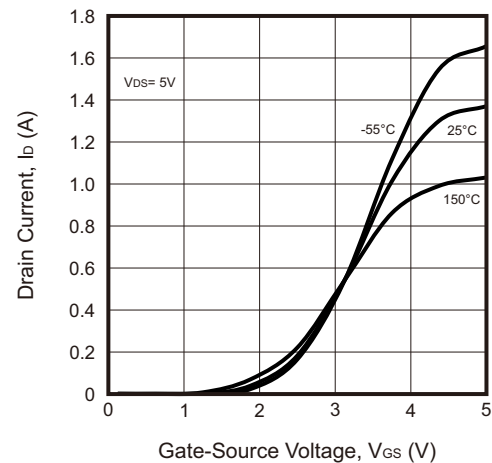

Fig.6 - Transfer Characteristics



Rating and Characteristic Curves (ABSS138ES-HF)

Fig.7 - Gate Voltage vs. Junction Temperature

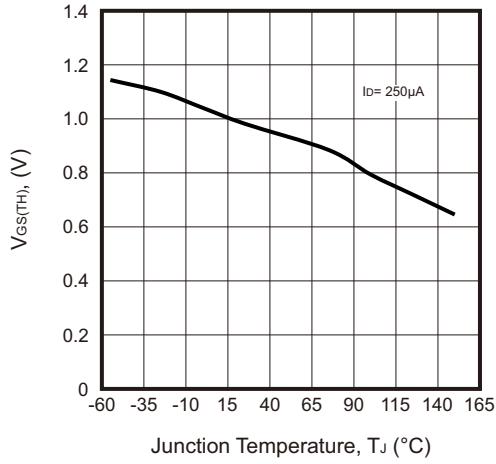

Fig.8 - Drain Source vs. Junction Temperature

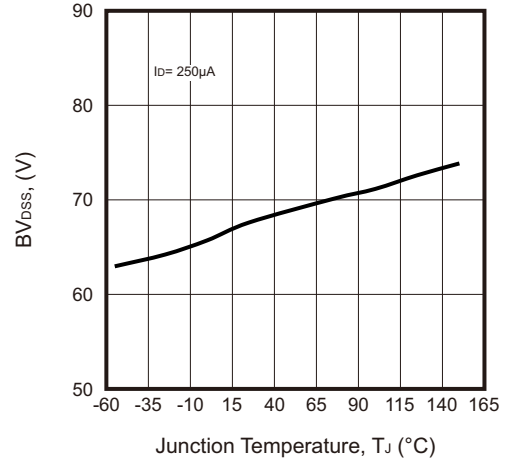

Fig.9 - Capacitance Characteristics

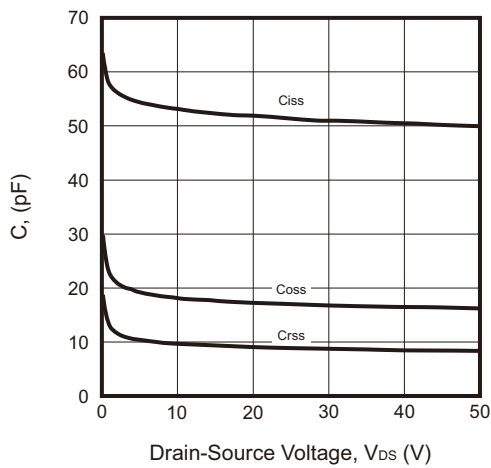
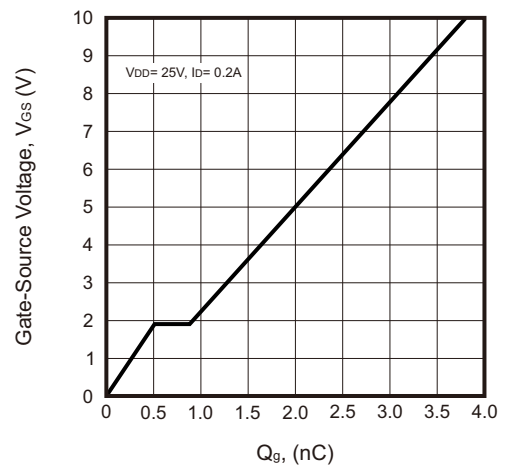
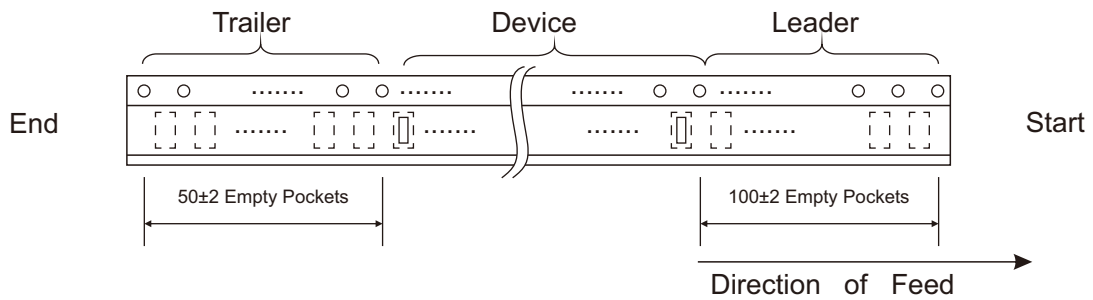
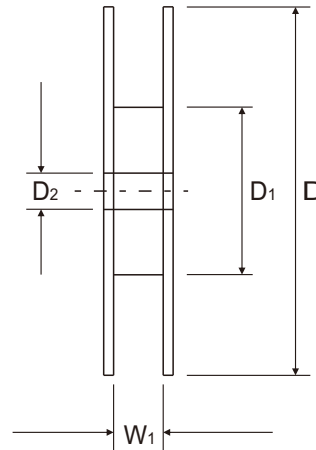
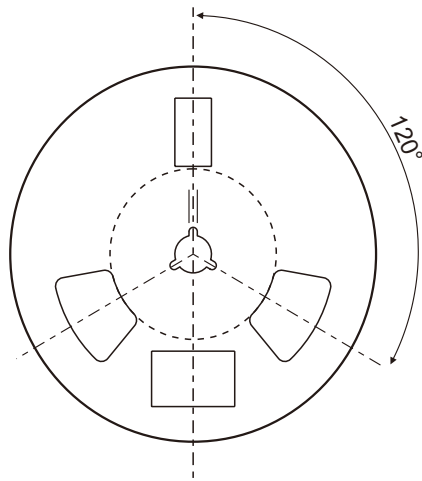
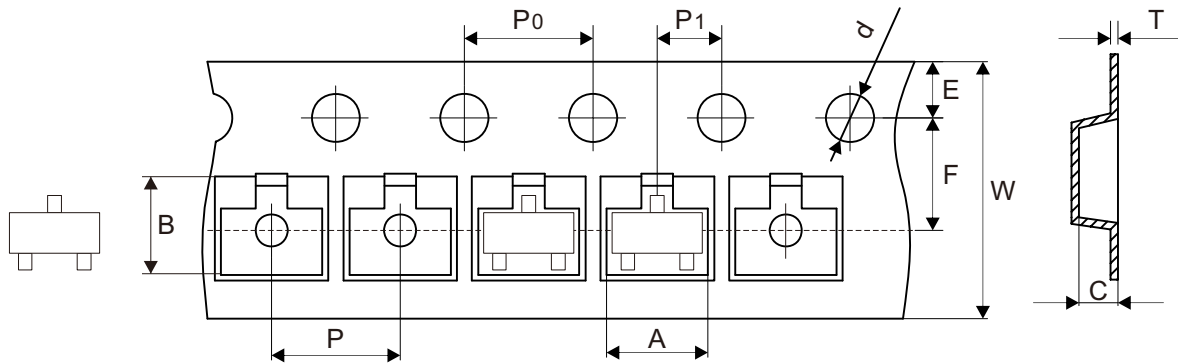

Fig.10 - Gate-Charge Characteristics



Reel Taping Specification



SOT-23	SYMBOL	A	B	C	d	D	D1	D2
	(mm)	3.15 ± 0.10	2.77 ± 0.10	1.22 ± 0.10	1.50 ± 0.10	178.00 ± 1.00	54.00 ± 0.50	13.00 ± 0.50
	(inch)	0.124 ± 0.004	0.109 ± 0.004	0.048 ± 0.004	0.059 ± 0.004	7.008 ± 0.039	2.126 ± 0.020	0.512 ± 0.020

SOT-23	SYMBOL	E	F	P	P0	P1	T	W	W1
	(mm)	1.75 ± 0.10	3.50 ± 0.10	4.00 ± 0.10	4.00 ± 0.10	2.00 ± 0.05	0.20 ± 0.02	8.00 ± 0.30	9.50 ± 1.00
	(inch)	0.069 ± 0.004	0.138 ± 0.004	0.157 ± 0.004	0.157 ± 0.004	0.079 ± 0.002	0.008 ± 0.001	0.315 ± 0.012	0.374 ± 0.039

Marking Code

Part Number	Marking Code
ABSS138ES-HF	MM5

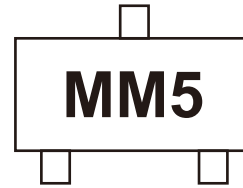

Suggested P.C.B. PAD Layout

SIZE	SOT-23	
	(mm)	(inch)
A	0.90	0.035
B	0.80	0.031
C	0.95	0.037
D	2.00	0.079
E	2.90	0.114

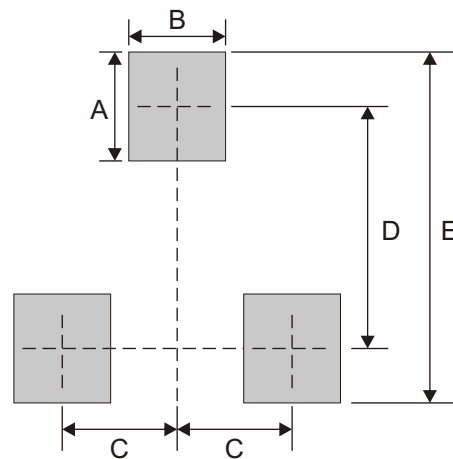

Standard Packaging

Case Type	REEL PACK	
	REEL (pcs)	Reel Size (inch)
SOT-23	3,000	7